

# RACRETE

CONCRETE WALL SURFACES

2024

# ABOUT US

---

Racrete studio is a design, research & development lab facilitating the creation of unique concrete decor, bespoke 3D tile designs while offering customised colours, patterns and style to match individual tastes.

We bring your architectural dreams to life in our state of the art concrete manufacturing facility based in Bangalore.

Our aim is to work in close cooperation with designers and architects to design spaces that are unique to each client which helps us achieve unique wall surfaces and decor.





## HANDMADE IN INDIA

---

All our products are hand crafted with meticulous precision.

We focus on attention to detail to achieve artisanal excellence in each of our pieces, which are unique & authentic. Our manufacturing process is sustainable & ethical with zero emission and use of very less water unlike traditional stones like marble & granite, which makes it a green building material.



RACRETE

# ABOUT OUR MATERIAL

---

The nature of concrete as a material has always been very inspiring as it is poured in a liquid state, and takes its ultimate form as it cures. There is poetry in a material that finds its form as it changes phases from liquid to a solid state.

Our material (UHPC) is a specialised type of concrete that exhibits enhanced durability, strength, and workability compared to traditional concrete mixes giving our products an Industry Leading finish.

UHPC involves the careful selection of high-quality raw materials, including high-performance cement, aggregates, pigments, glass fibres and supplementary cementitious materials, to achieve the desired finish and strength.





# STAIN & WATER-REPELLENT TREATMENT

---

Our products are treated with a double coat of penetrating sealers in temperature controlled chambers. This makes our concrete 3D tiles and panels UV safe, water and stain resistant hence making it suitable for use in both indoor and outdoor areas. These coatings when applied to concrete surfaces, protect them from various elements and enhance their durability.





RACRETE

*Surfaces*

## WALL PANELS

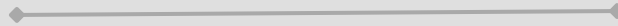

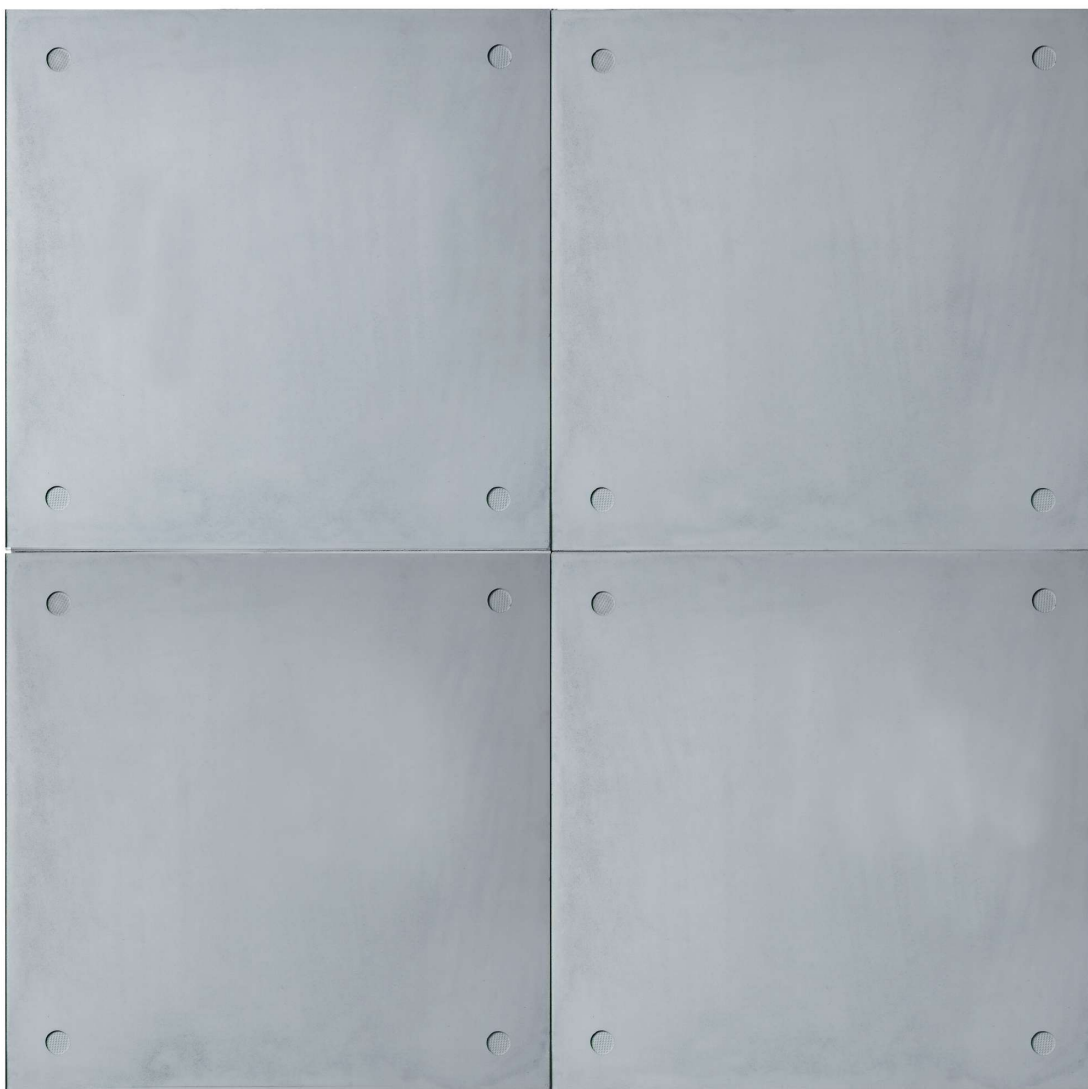

# NATURAL

---

These wall panels are simple, minimal and timeless. Its natural texture is inspired by exposed concrete walls which have been used for generations. The subtle mottling tones and shade variations give these panels a raw authentic look and our signature textured button adds a touch of elegance to these panels.

---

## Technical Specifications :

Available Sizes :

- 2 Ft. x 2 Ft.
- 18 inch x 18 inch
- 4 Ft. x 1 Ft.
- 3 Ft. x 1 Ft.

Thickness : 12mm

Note : Sizes and colour can be customised as per your requirement. Mix and Match different sizes and colours to create a unique look.

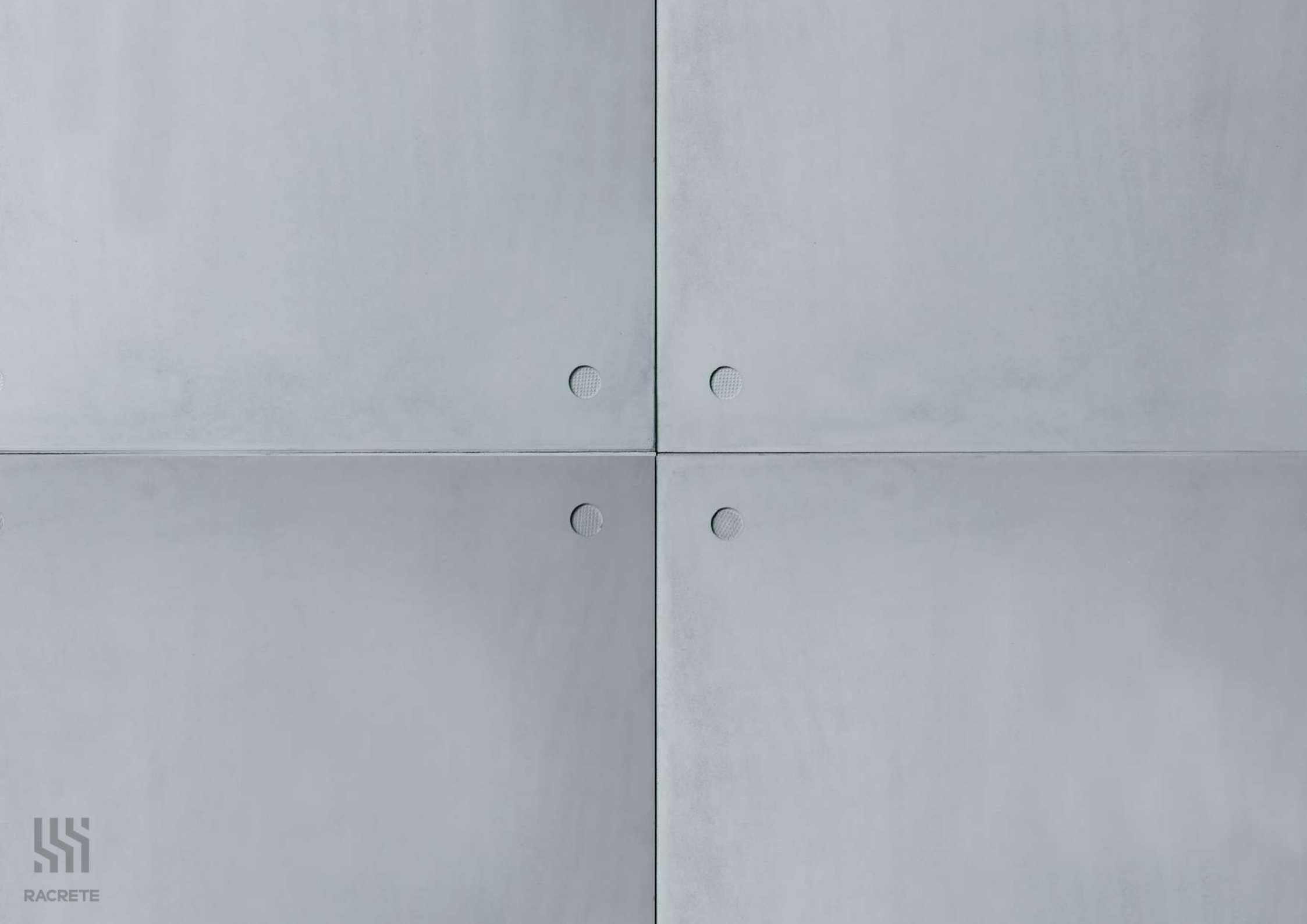

RACRETE







# DISTRESSED

---

Add a rustic look to any space with these raw unfinished concrete panels. The porous texture and deliberate pin holes of various sizes make these walls stand out of the rest. Create breath taking walls by combining different size and thickness of these panels to create unique one of a kind installations.

---

## Technical Specifications :

Available Sizes :

- 2 Ft. x 2 Ft.
- 18 inch x 18 inch
- 4 Ft. x 1 Ft.
- 3 Ft. x 1 Ft.

Thickness : 12mm

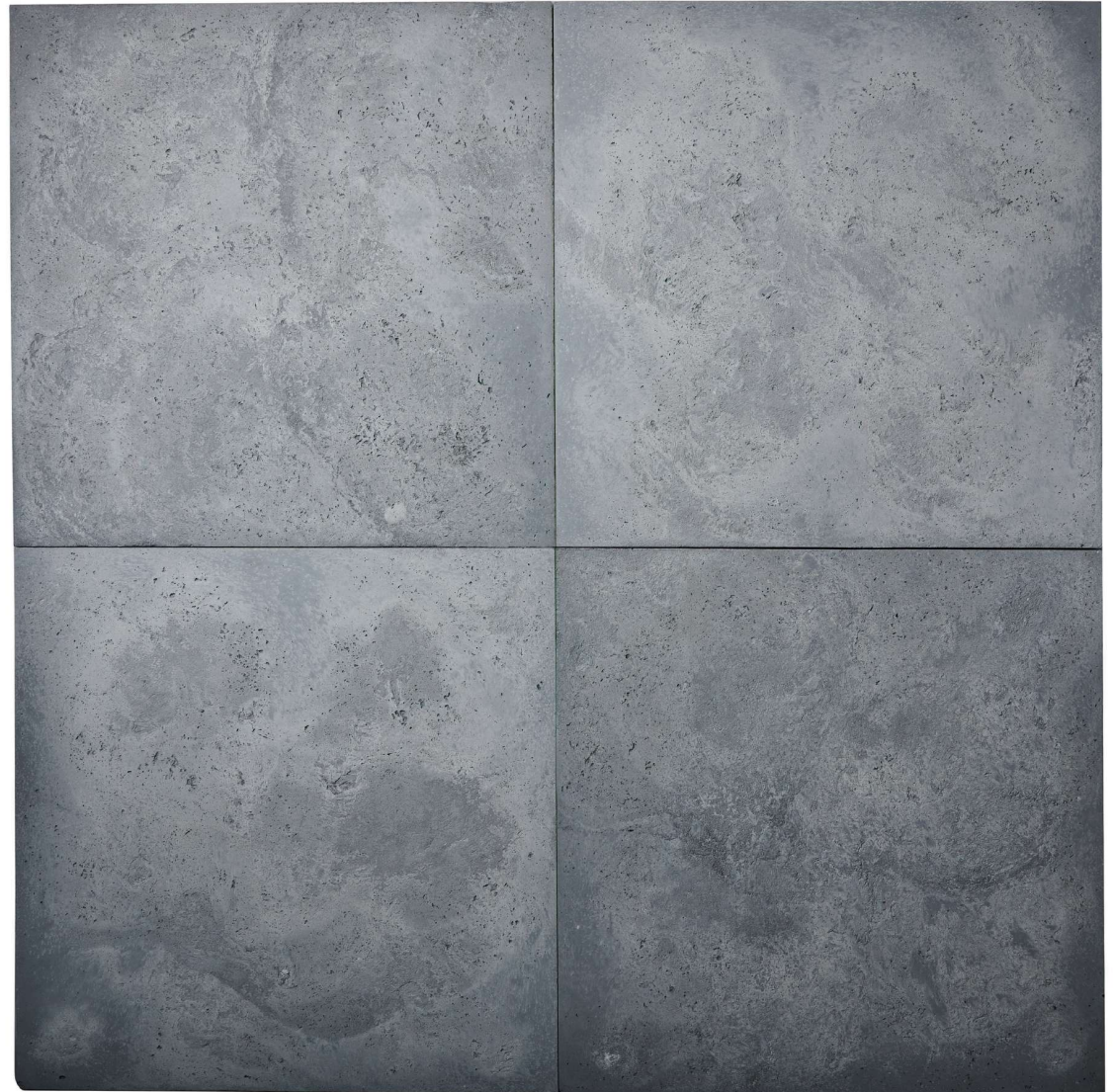

Note : Sizes and colour can be customised as per your requirement. Mix and Match different sizes and colours to create a unique look.



RACRETE



RACRETE

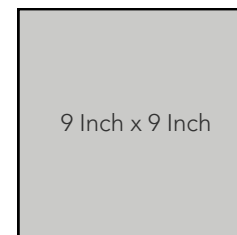
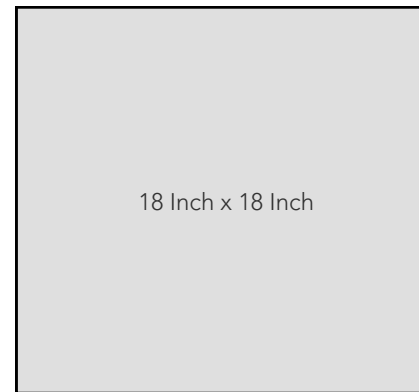

## MIX & MATCH

Use different sizes and thickness variations to bring out the best of these panels.

The changing shadows on the wall due to variations make it look alive all through the day.

Thickness Options :8mm, 14mm, 20mm & 26mm.







# LAVA

---

Deliberate pin holes infused on these panels gives it a rigid unrefined look which adds layers to any space. Subtle textures on these panels add an inviting sense of touch to the space making walls look classy and stunning.

---

## Technical Specifications :

Available Sizes :

- 2 Ft. x 2 Ft.
- 18 inch x 18 inch
- 4 Ft. x 1 Ft.
- 3 Ft. x 1 Ft.

Thickness : 12mm

Note : Sizes and colour can be customised as per your requirement. Mix and Match different sizes and colours to create a unique look.







RACRETE





RACRETE

# METAL INLAY

---

These sophisticated panels combine the durability of concrete with the aesthetic appeal of metal inlay. The little shine from the metal inlays make these panels pop and visually very attractive. Simple yet elegant making it suitable for any space needing an upscale appearance.

These panels are a class apart.

---

## Technical Specifications :

Available Sizes :

- 2 Ft. x 2 Ft.
- 18 inch x 18 inch
- 4 Ft. x 1 Ft.
- 3 Ft. x 1 Ft.

Thickness : 12mm

Note : Sizes and colour can be customised as per your requirement. Mix and Match different sizes and colours to create a unique look.

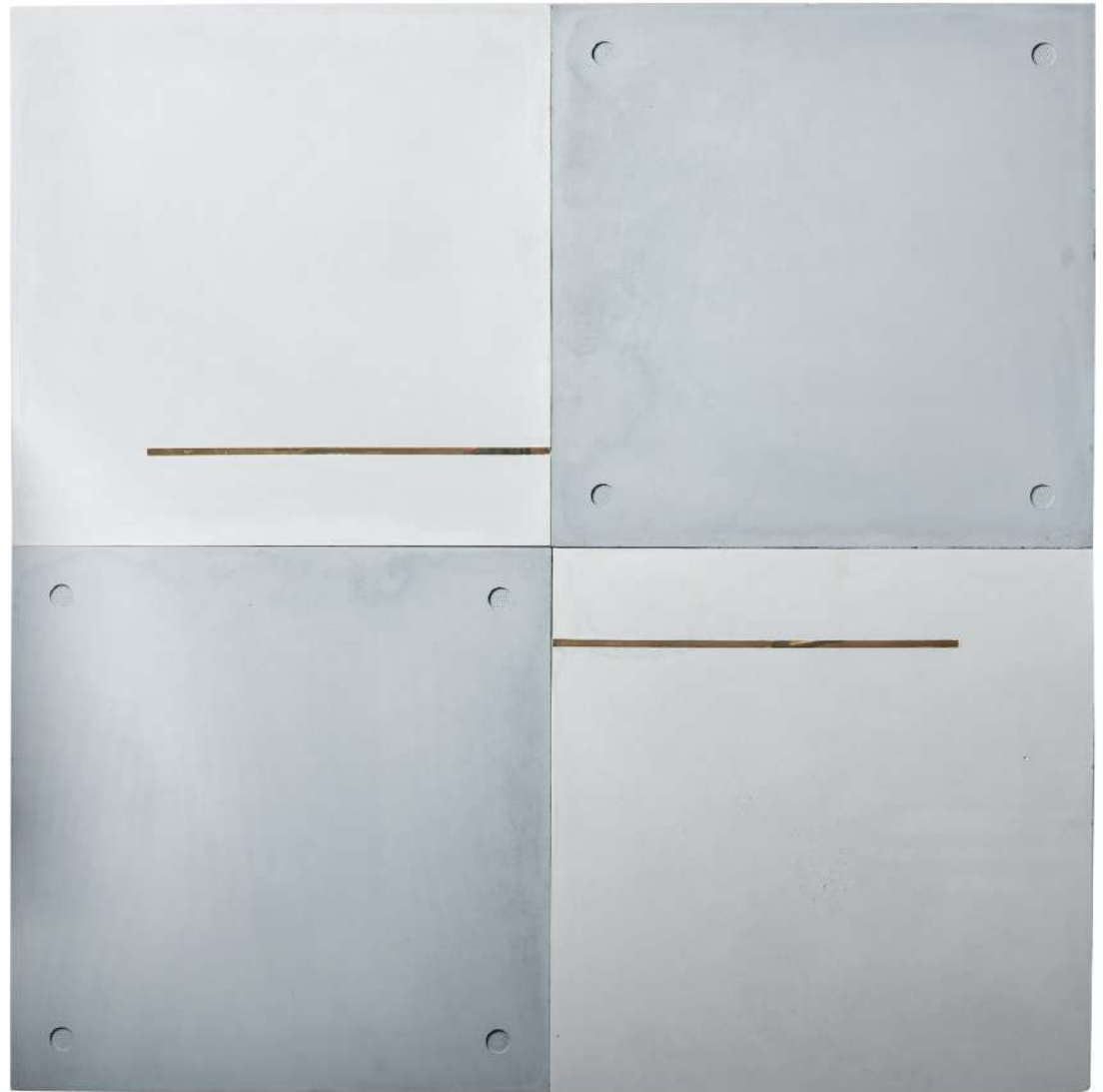

RACRETE



RACRETE



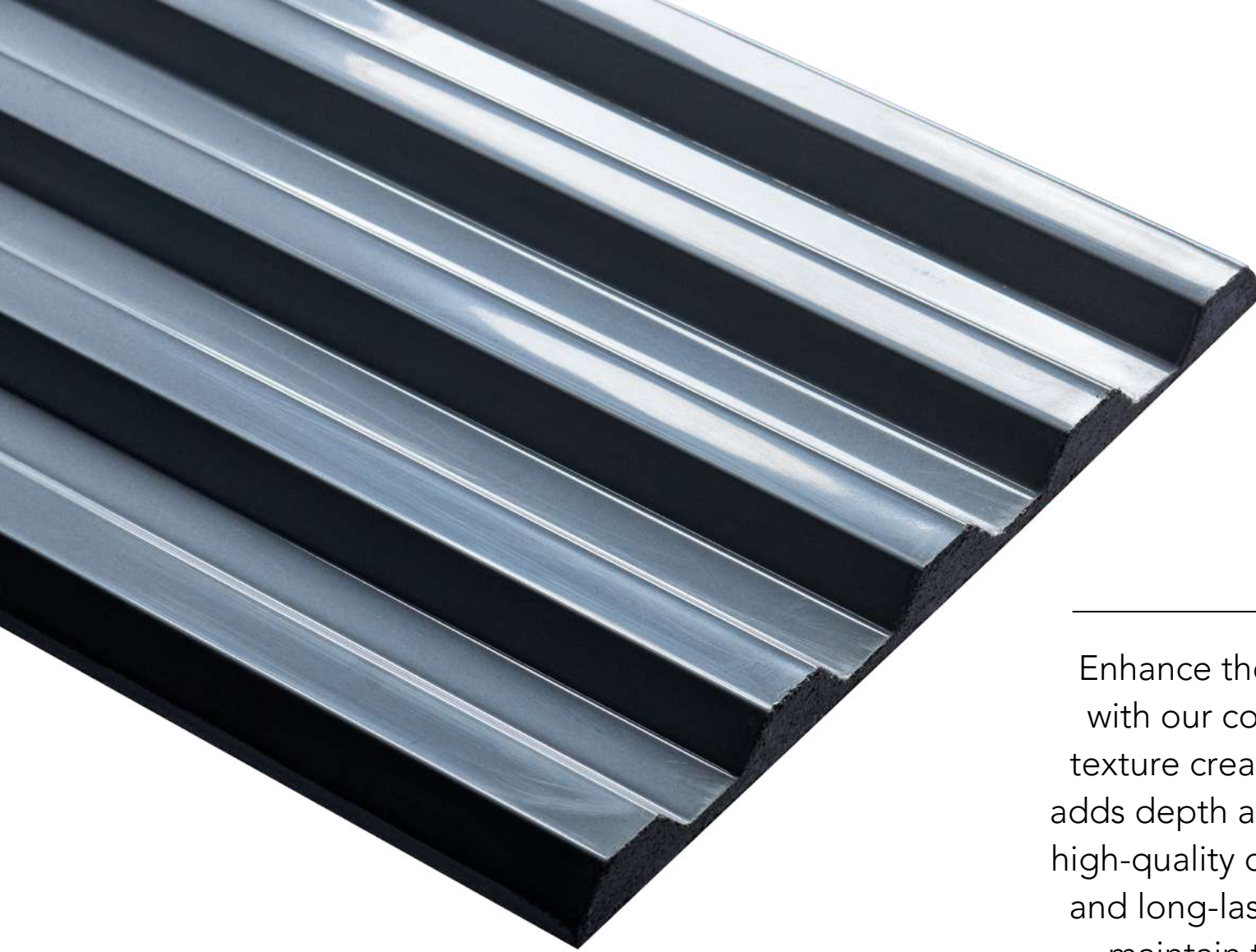

## FLUTE

---

Enhance the aesthetic appeal of your space with our concrete fluted panels. The fluted texture creates a visually striking pattern that adds depth and dimension to walls. Made from high-quality concrete, these panels are durable and long-lasting, ensuring that your walls will maintain their beauty for years to come.

---

### Technical Specifications :

Available Size : 1219 mm x 355 mm

Thickness : 30mm





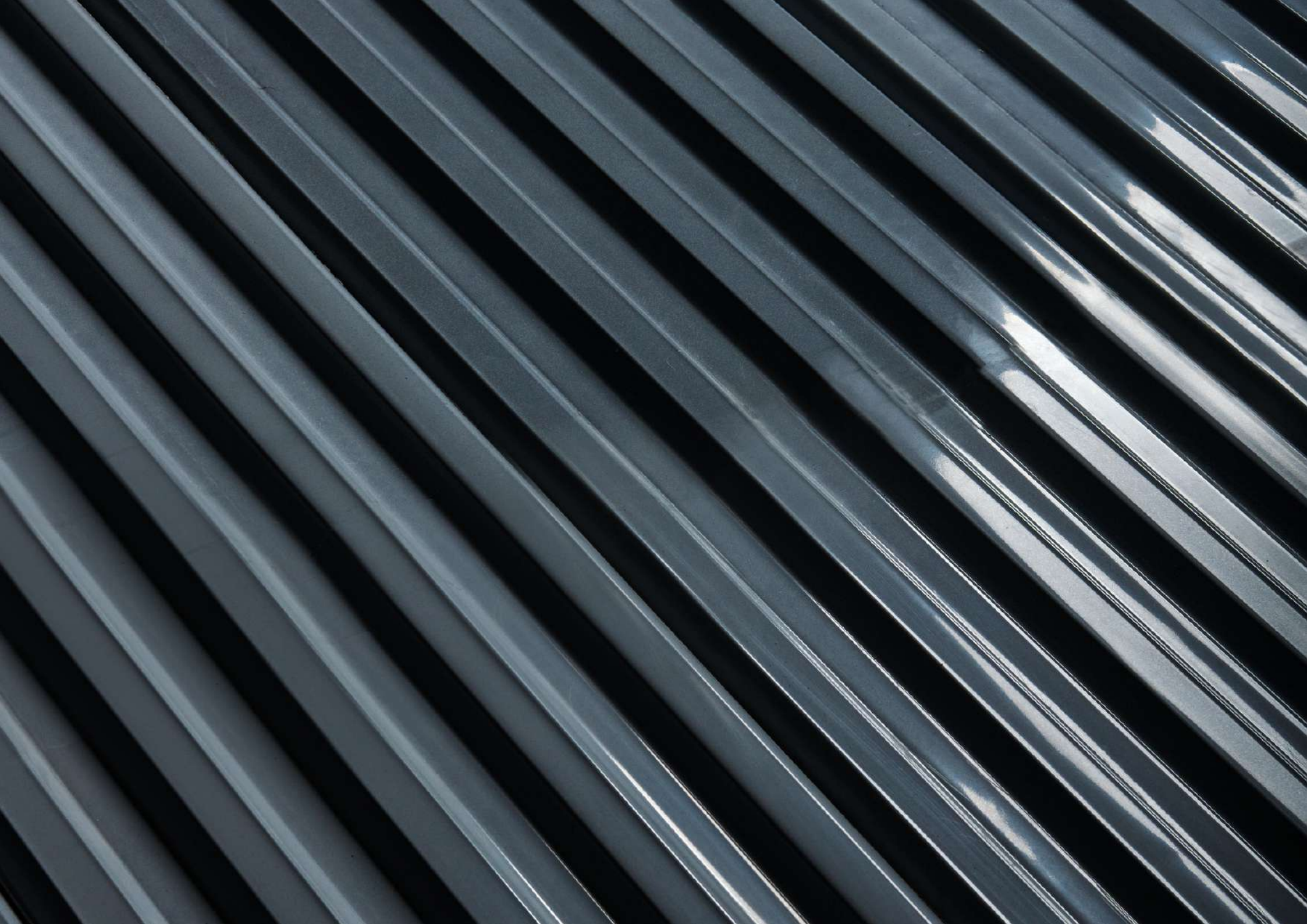



## PEEL - BEND

---

With a subtle deviation from the regular tile form our bend panels transforms spaces into a captivating visual experience. These wall panels are intentionally designed with a gentle bend to make it look like peels and by adding warm lights behind the bends makes spaces intriguingly stunning. This work of art is a revolution in wall surfaces.

---

### Technical Specifications :

Available Sizes :

- 4 Ft. x 1 Ft.
- 3 Ft. x 1 Ft.

Thickness : 12mm







# BULGE - BEND

---

Another variation of our revolutionary bend panel is the Bulge. It looks like a hump in the wall and adds intriguing 3D elements to plain walls. Redefine spaces and add a touch of modern and minimal art to your walls. When paired with lights beneath the humps, these installations can elevate spaces visually in any commercial or residential setting making walls truly come alive.

---

## Technical Specifications :

Available Size : 4 Ft. x 1 Ft.

Thickness : 12mm







RACRETE

*Surfaces*

## 3D WALL TILES





# HIVE

---

HIVE incorporates tactile 3D elements for bold accent walls. Balancing style and innovation for luxurious commercial spaces as well as the modern home.

Each tile in the series works as well independently as it does in multi tile combinations and maintains its visual appeal even in random configurations.

These concrete tiles are a statement in modern tile design and leaves room for limitless interpretations mixing and matching various designs made from our finest material

---

**Coverage Area :**

1 Sq. Ft. = ~ 6.2 tiles

**Dimensions :**

3D Tile : 150 mm x 130 mm x 25 mm (LBH)

Flat Tile : 150 mm x 130 mm x 11 mm (LBH)











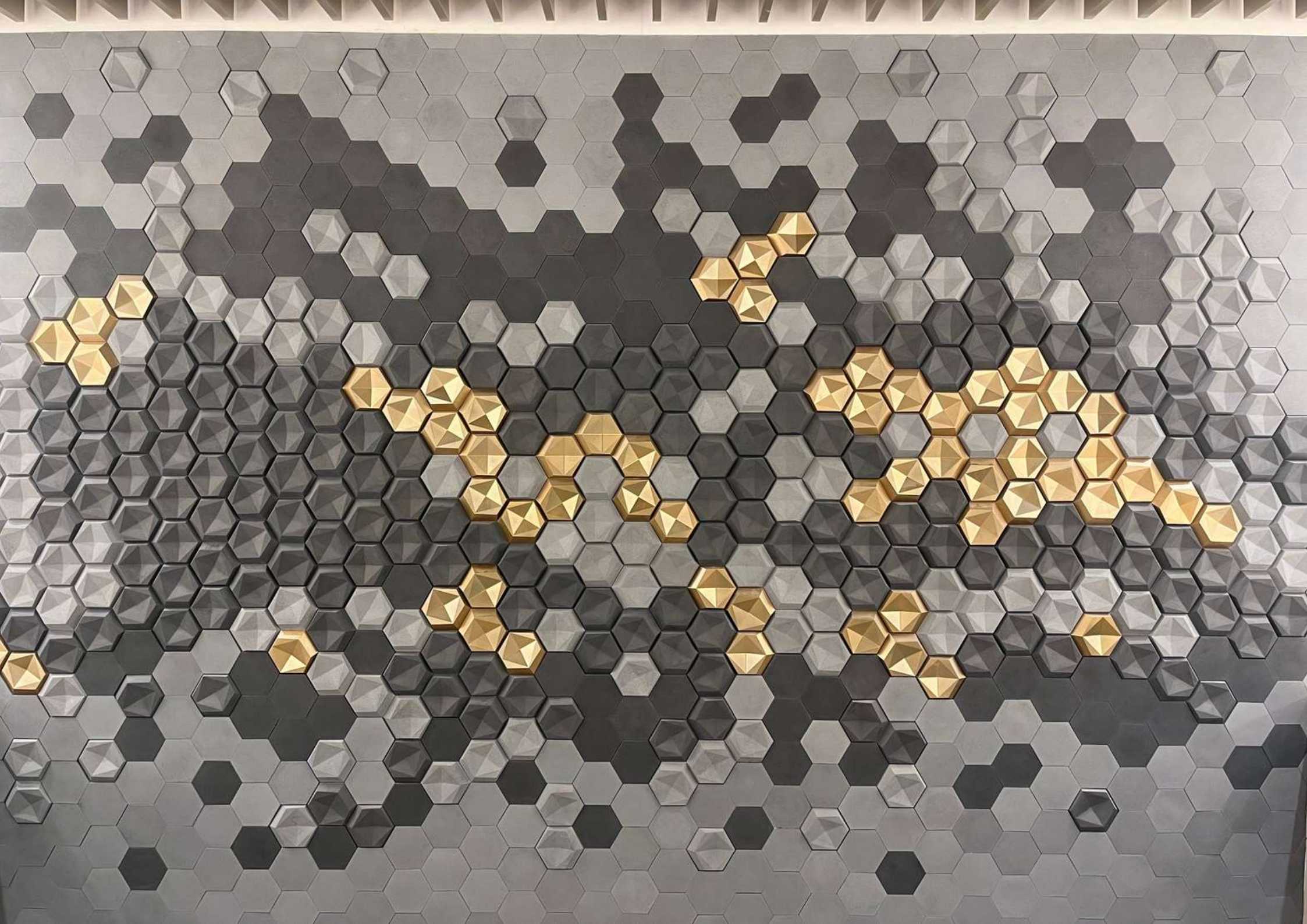









## TRE

---

TRE's magnetic visual appeal is the result of precisely rendered angular contours that harness the beauty of symmetry, as well as the dynamic interplay of depth, light and shadow.

Add structure to smooth walls on interior or exterior surfaces, covering walls either partially or entirely to create visually stunning spaces.

---

**Coverage Area :**

1 Sq. Ft. = ~ 4.8 tiles

**Dimensions :**

3D Tile : 184 mm x 213 mm x 30 mm (LBH)

Flat Tile : 184 mm x 213 mm x 10 mm (LBH)





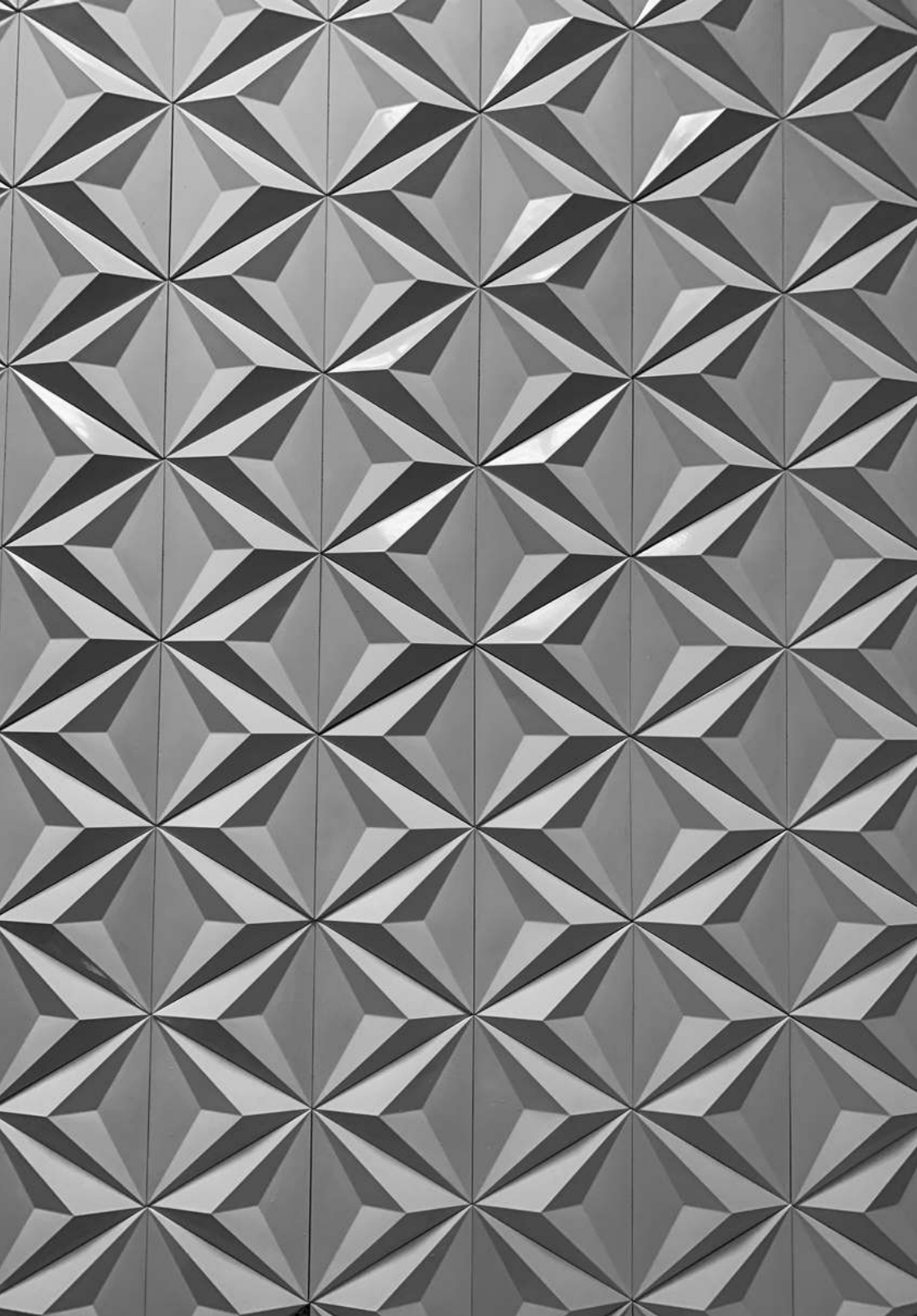

# WORK IN PROGRESS

---





RACRETE



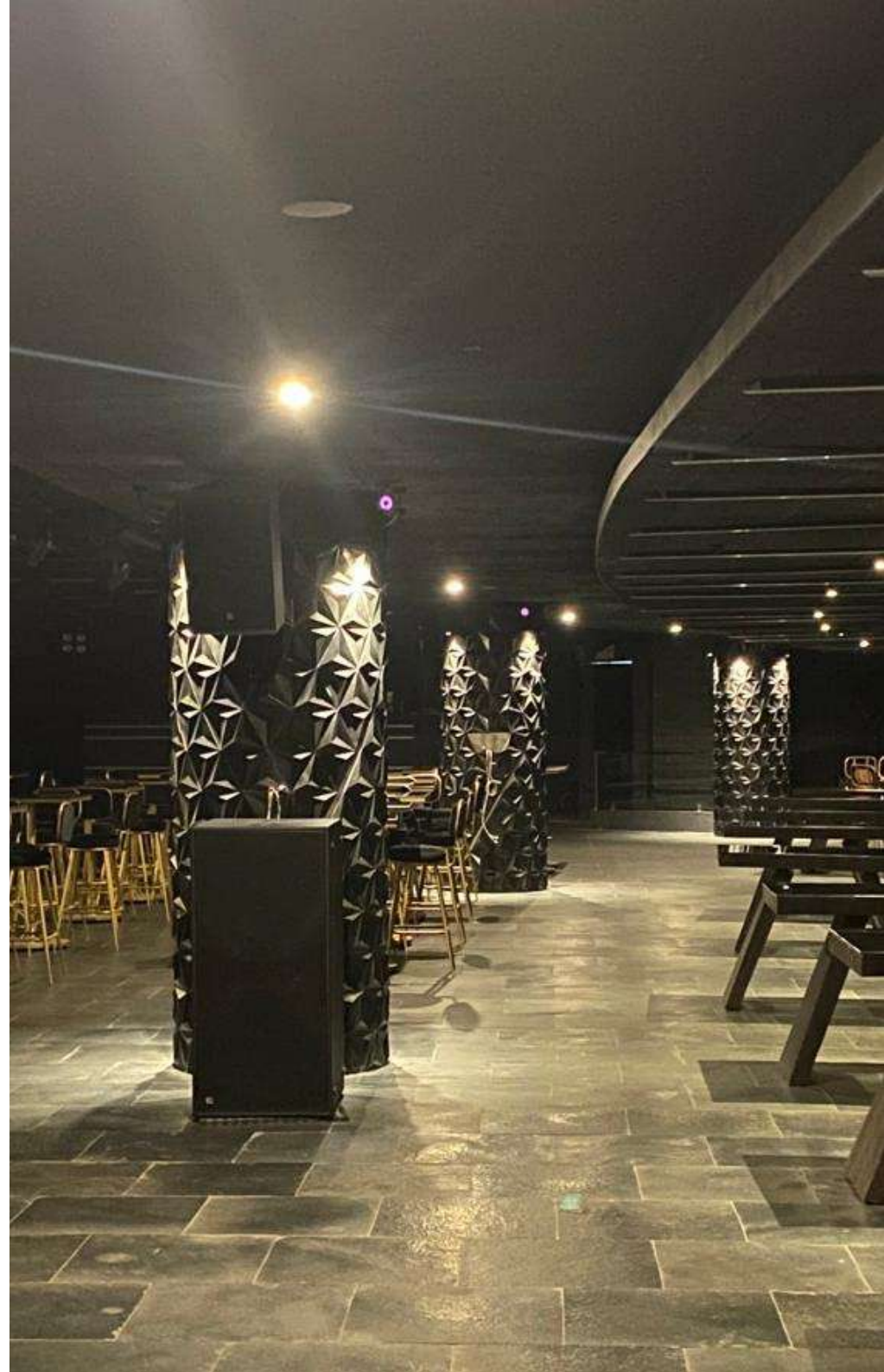



## PRISM

---

Prism is simple in structure and repetitive in form.

It is a classic design well suited for any environment which helps transform any space into a captivating storytelling experience. With mesmerising patterns and a touch of modernity, these tiles invite you to imagine the tales that these walls could share if they could speak.

---

**Coverage Area :**

1 Sq. Ft. = ~ 4.8 tiles

**Dimensions :**

3D Tile : 184 mm x 213 mm x 38 mm (LBH)

Flat Tile : 184 mm x 213 mm x 10 mm (LBH)



PACRETE

**IF THESE  
WALLS COULD  
SPEAK**











## SPECKKA

---

The unique combination of linear hexagon shape and three-dimensional texture adds depth and dimension to your walls, transforming them into a captivating focal point. Elevate your interior decor with these versatile and visually stunning tiles, offering endless possibilities for creating a truly personalized and stylish ambiance.

---

**Coverage Area :**

1 Sq. Ft. = ~ 3.5 tiles

**Dimensions :**

3D Tile : 298 mm x 131 mm x 25 mm (LBH)

Flat Tile : 298 mm x 131 mm x 10 mm (LBH)









RACRETE



# QUADRO

---

These 3D Diamond shaped tiles are not only visually appealing but also durable and long-lasting, ensuring that your walls will remain stylish for years to come. Transform your space with these unique and versatile tiles, adding a touch of elegance and sophistication to any room. Mixing and matching 3D with flat tiles to bring out the three dimensional effect on any wall surface.

---

**Coverage Area :**

1 Sq. Ft. = ~ 6 tiles

**Dimensions :**

3D Tile : 232 mm x 134 mm x 23 mm (LBH)

Flat Tile : 232 mm x 134 mm x 10 mm (LBH)

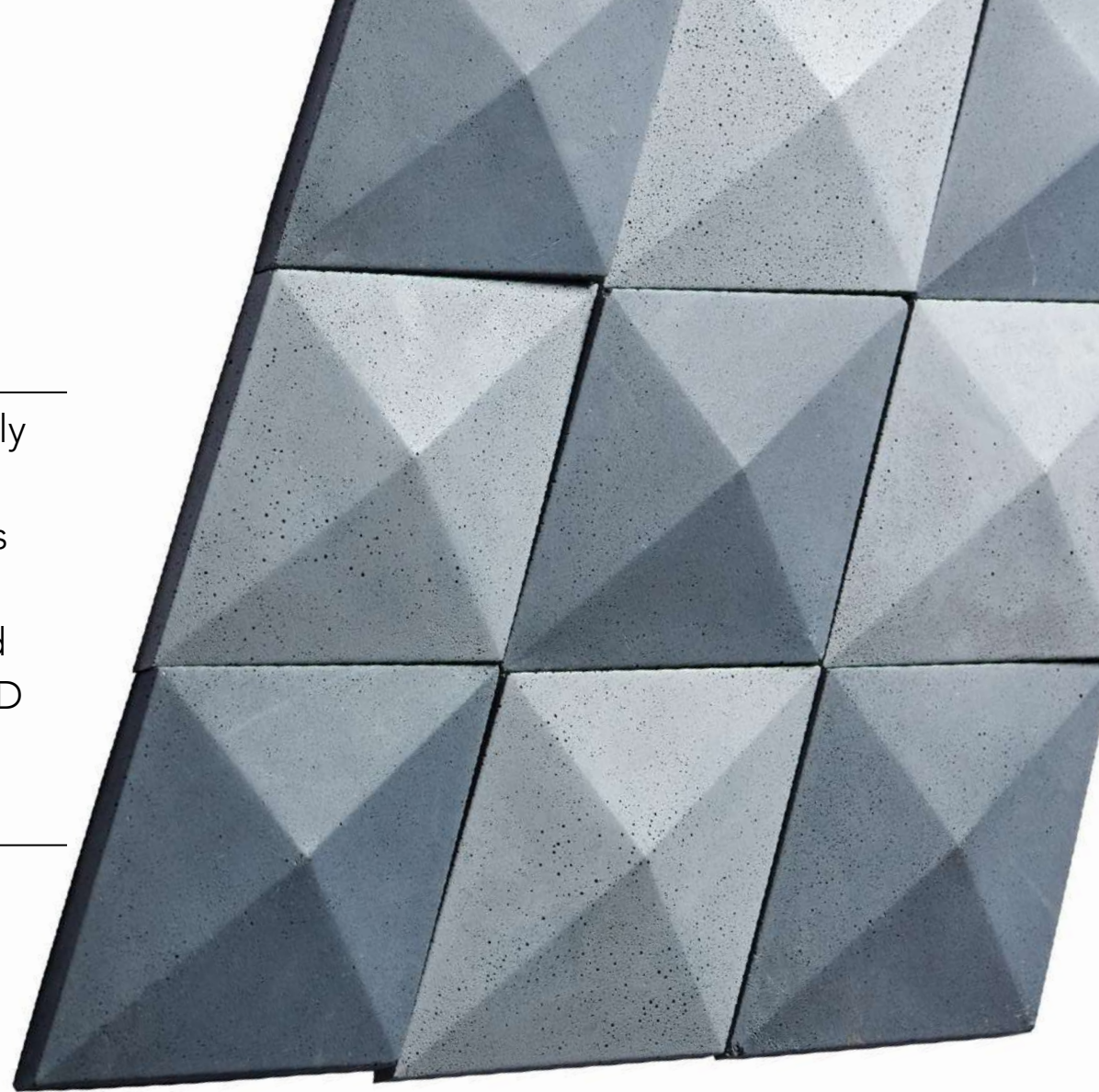

RACRETE





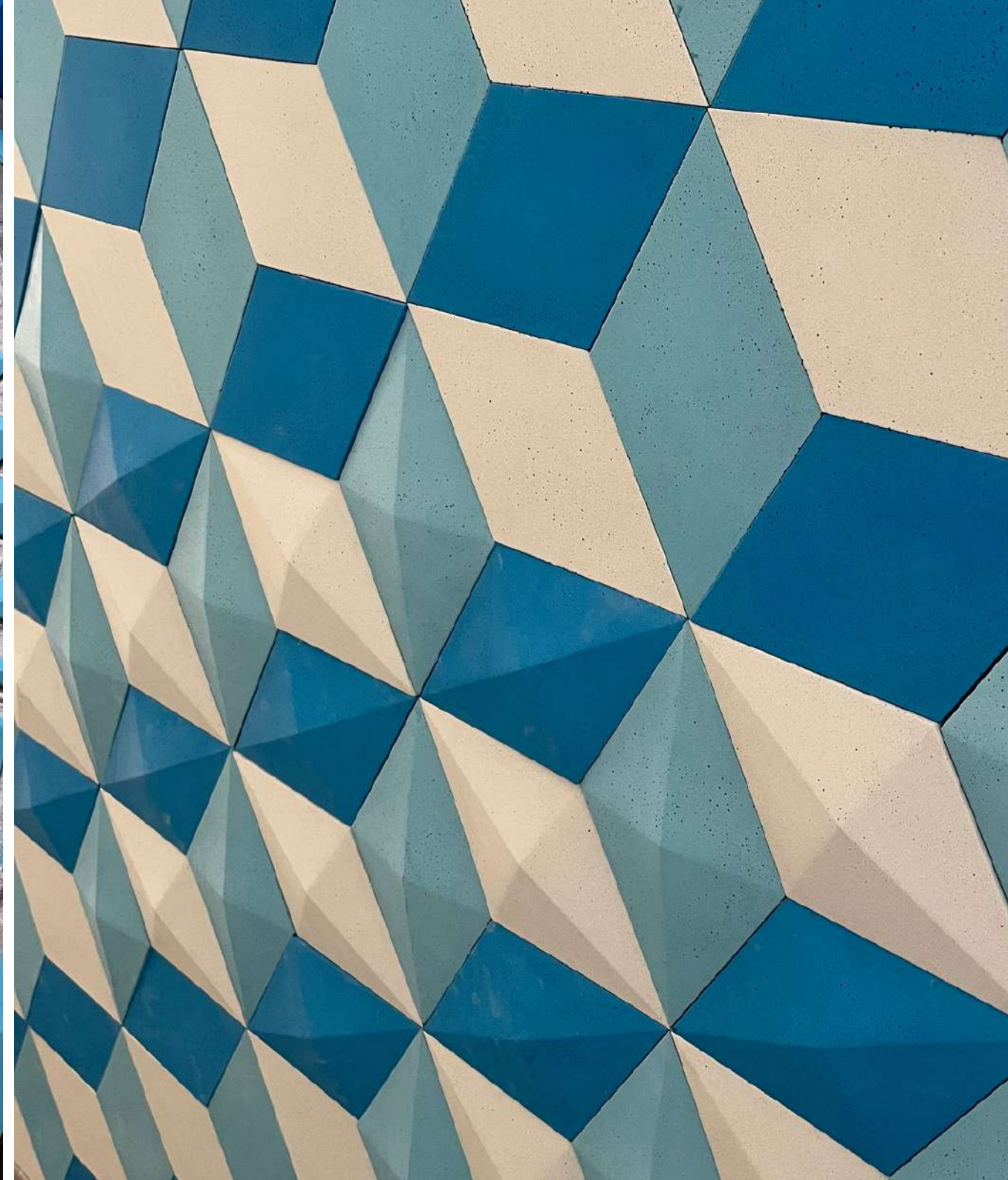





## FLOW

---

This design brings out the expression of flow and movement in a solid state. It is made up of two individual pieces designed as one which seamlessly blends together to create a sense of flowing on the wall surface. Give your walls a fluidic touch with this captivating design.

---

**Coverage Area :**

1 Sq. Ft. = ~ 1.25 tiles

**Dimensions :**

3D Tile : 330 mm x 220 mm x 33 mm (LBH)



RACRETE





## CONVEX

---

This tile takes inspiration from 3 little leaves branching out from one stalk, creating a pure and modern visual conception. The playful yet simple lines and the 3D arrangement envision the image of a tidy field of clovers. Intricate design and high-quality materials create a visually striking and modern aesthetic.

---

**Coverage Area :**

1 Sq. Ft. = ~ 1.75 tiles

**Dimensions :**

3D Tile : 250 mm x 287 mm x 20 mm (LBH)















# TECHNICAL SPECIFICATION (3D Tiles)

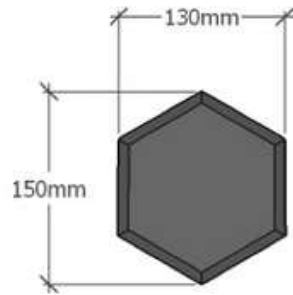

HIVE

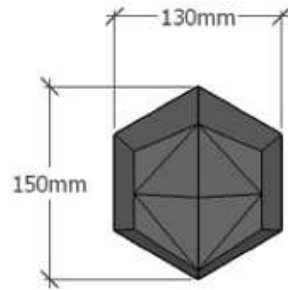

FLOW

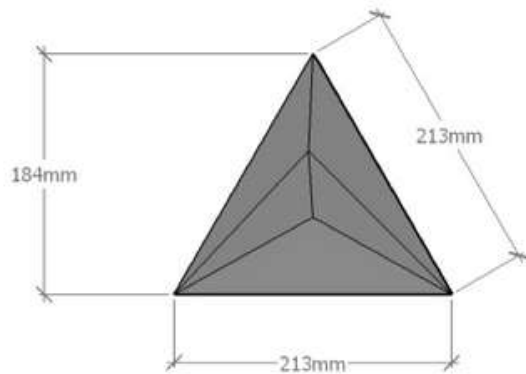
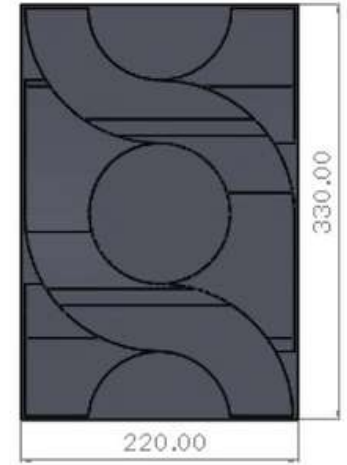

TRE

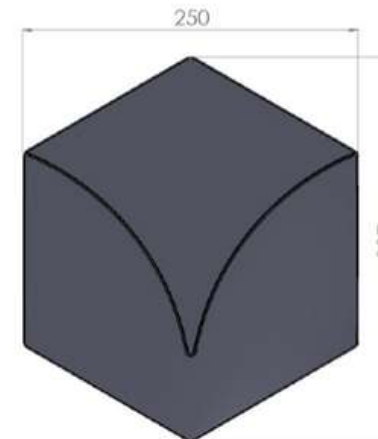
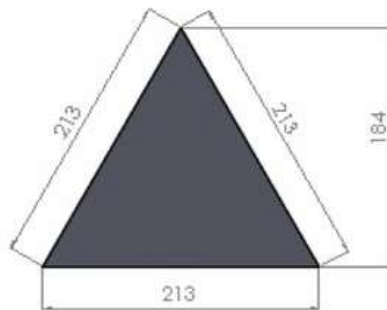

CONVEX



# TECHNICAL SPECIFICATION (3D Tiles)

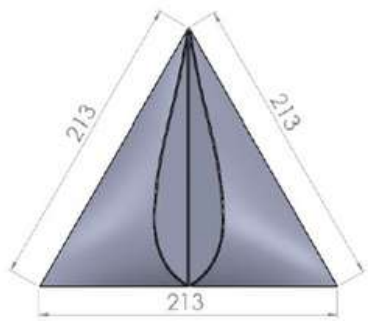

PRISM

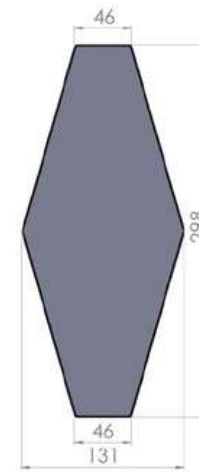
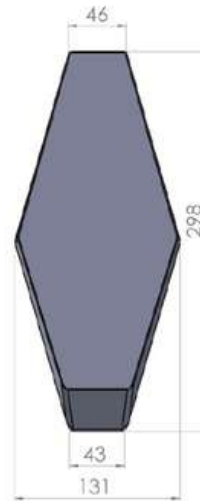

SPECKA



QUADRO



# TECHNICAL SPECIFICATIONS

---

Size: Variation of + or – 1% can be expected in dimension of architectural concrete products.

Thickness: Variation of + or – 5% can be expected in thickness of the architectural concrete products.

Pinholes/Air bubbles: The occurrence of air bubbles/holes is an inherent property of concrete, concrete naturally has air trapped in it while manufacturing.

Mottled tones & Colour: Concrete in its natural state has some mottled tones and a slight colour variation which gives the products its distinctive look.





# COLOURS



Gold (Metallic)  
RA-G01



Black (Metallic)  
RA-B02



White  
RA-W03



Storm Grey  
RA-GC04



Light Grey  
RA-LG05



Dark Grey  
RA-DG06

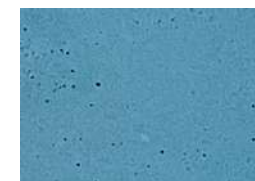

Candy Blue  
RA-LB07

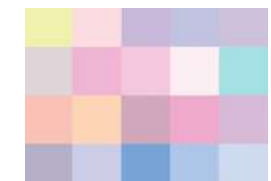

Customise your  
colour & shade

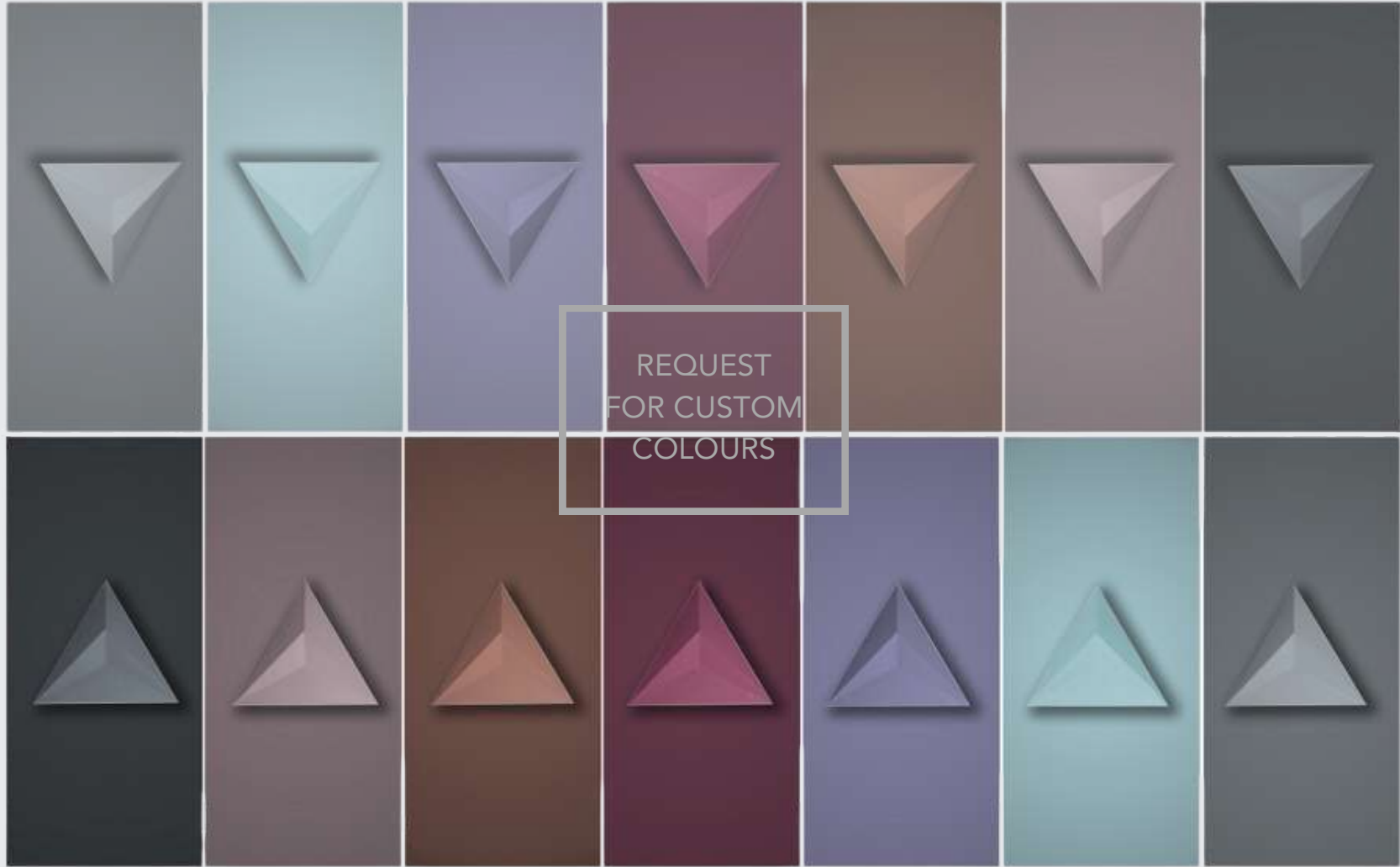

# INSTALLATION

---

We recommend two types of bonding method:



< 30 kg/m<sup>2</sup>

Cement based



U1, U2, R1, E5

Polymer based

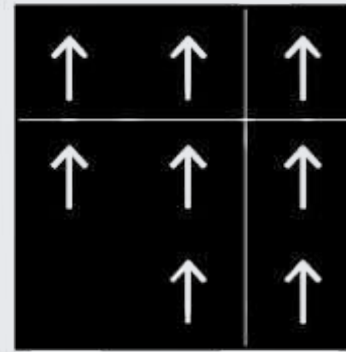

Always begin applying  
from the bottom.

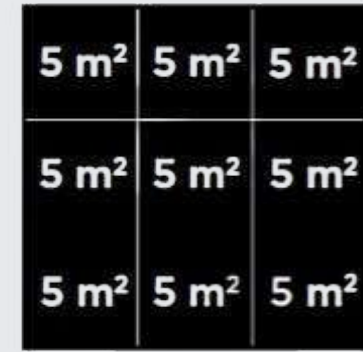

Large areas should be  
processed in sections.

Our 3D concrete tiles are UV safe, water and stain resistant and are suitable for both indoor and outdoor areas.

Installation of SPARR tiles can be done using cement or polymer based adhesives and all tiles can be cut to fit any surface of any size.

We recommend using KERAKOLL Super Flex Eco adhesives for hassle free installation.





PHONE : +91 93808 88246

EMAIL : racretestudio@gmail.com

WEBSITE : www.racrete.com

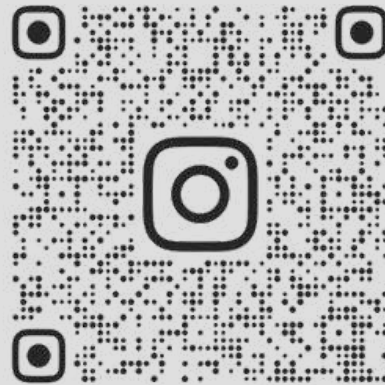

@RACRETE.STUDIO